





- |      |   |     |
|------|---|-----|
| x 2  |    | (R) |
| x 8  |    |     |
| x 8  |  |     |
| x 8  |  | (A) |
| x 56 |    | (X) |
| x 8  |  | (E) |
| x 8  |  | (D) |



1

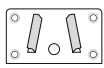
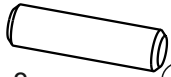

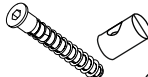
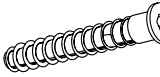
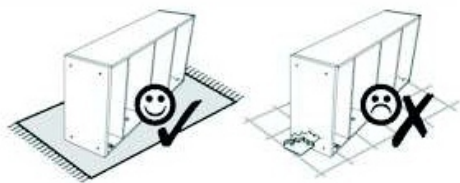
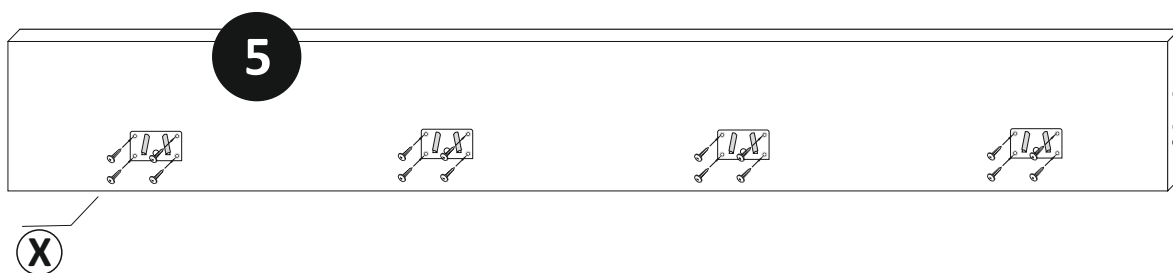
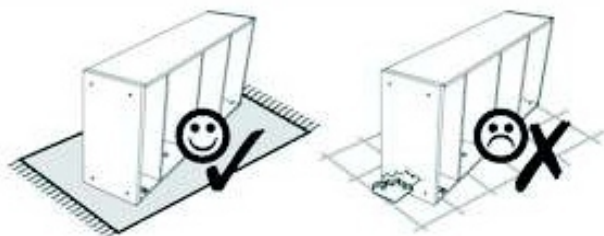

3

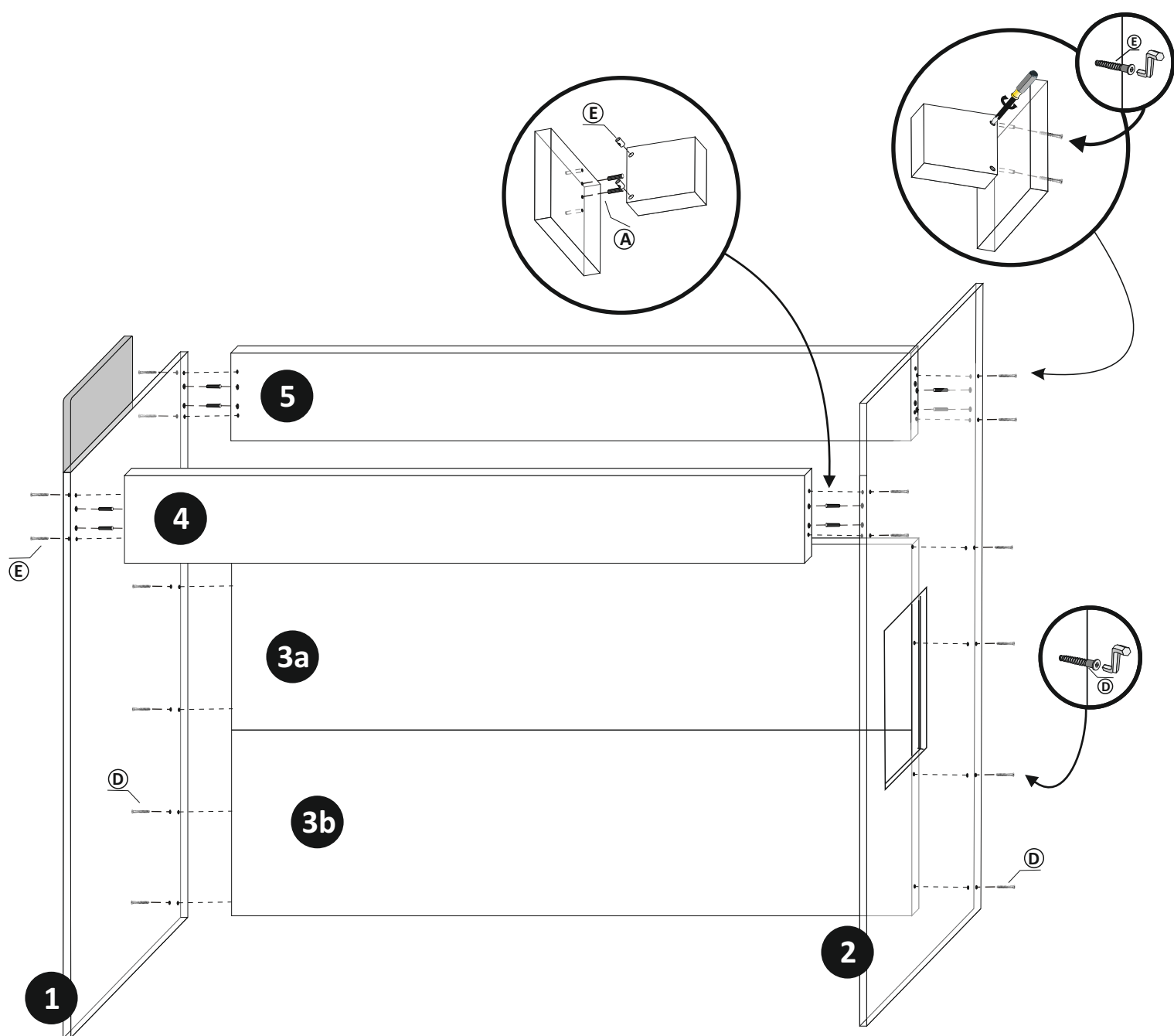

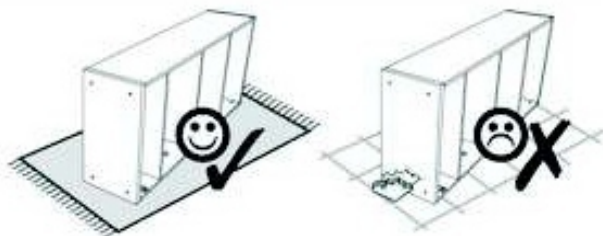

4

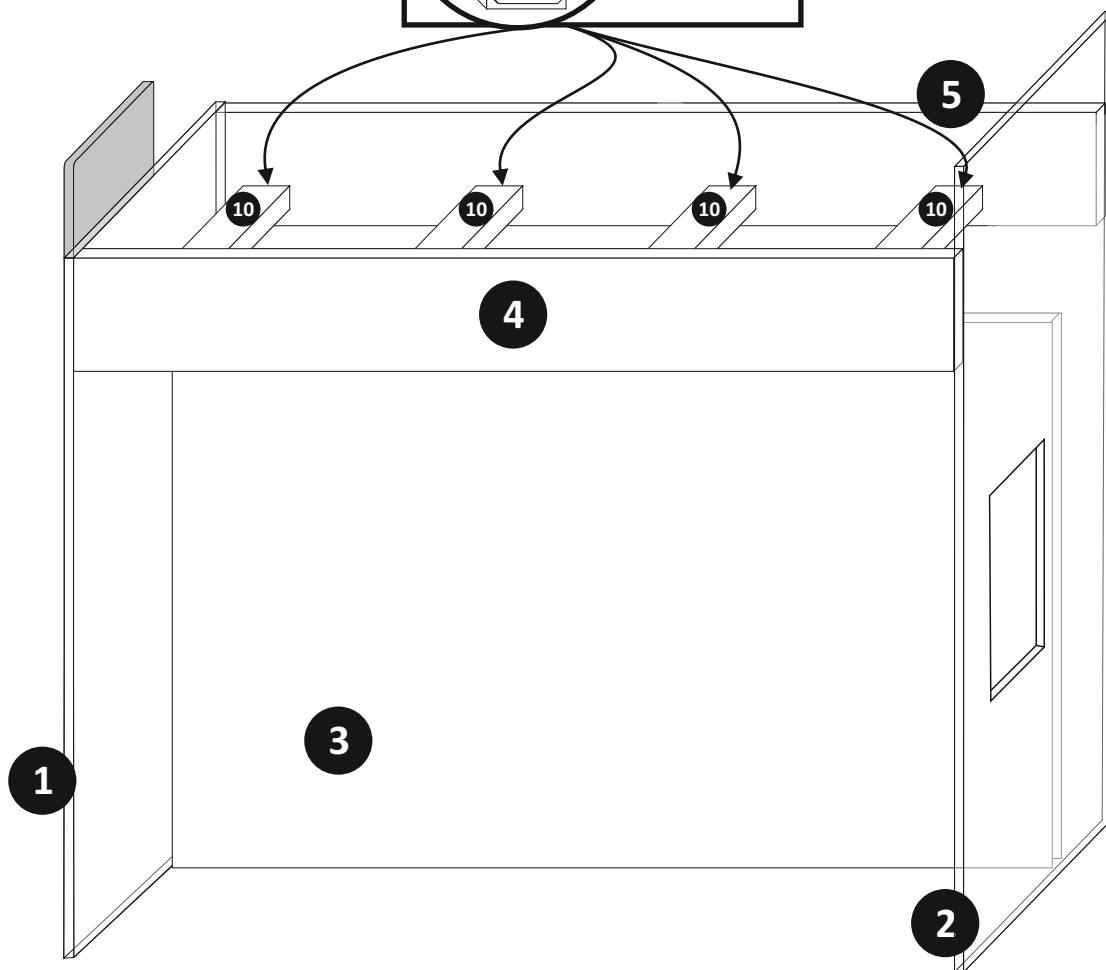
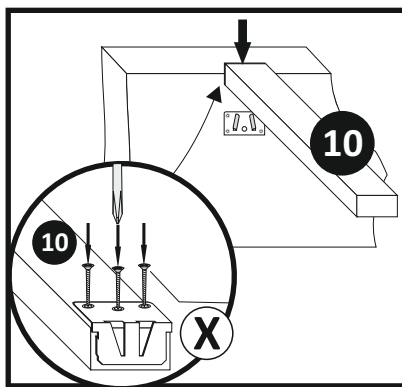

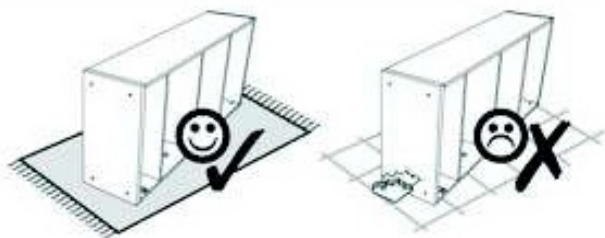

5

