

20 min

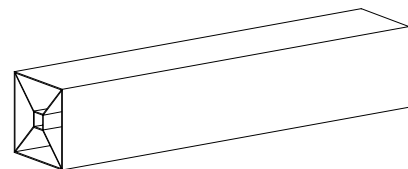

S - 1 St.

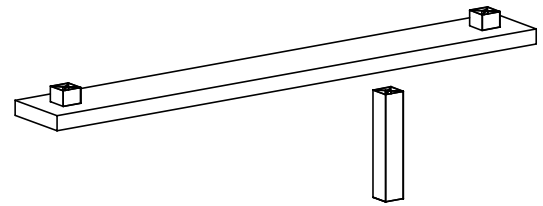
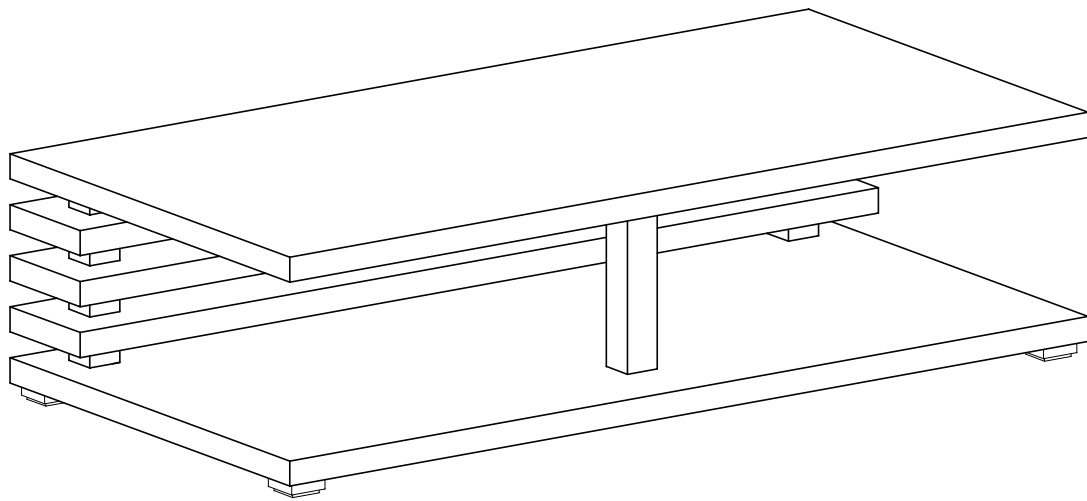
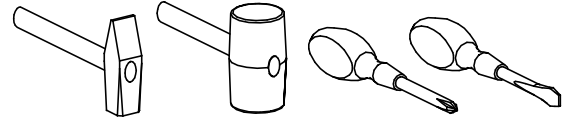
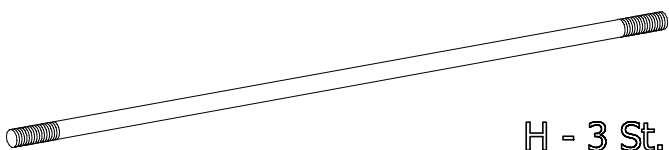

H - 3 St.

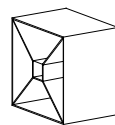

G - 8 St.

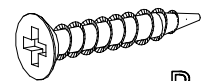

R - 16 St.
4 x 30 mm

B - 3 St.

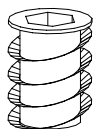

F - 3 St.

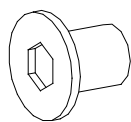

P - 4 St.

